



# CLA SERIES

COMMERCIAL LITE AMPLIFIERS

CLA804 / CLA404 / CLA802 / CLA402 / CLA202

OWNER'S MANUAL

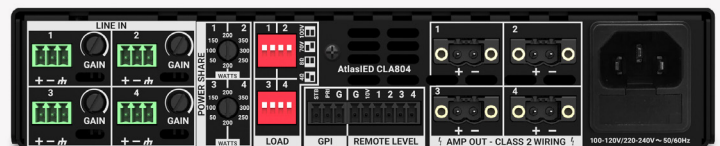
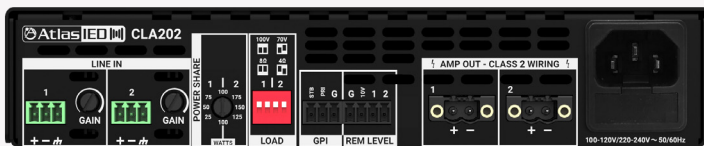

1601 JACK MCKAY BLVD.  
ENNIS, TEXAS 75119 U.S.A.

TELEPHONE: (800) 876-3333  
SUPPORT@ATLASIED.COM

AtlasIED.com

# CLA SERIES

## COMMERCIAL LITE AMPLIFIERS

CLA804 / CLA404 / CLA802 / CLA402 / CLA202



## OWNER'S MANUAL

### TABLE OF CONTENTS

Introduction.....	3
Key Features.....	3
Important Safety Instructions.....	4
Front Panel Description.....	6
Rear Panel Description.....	7
Cabling & Placement of the Amplifier.....	13
CLA Amplifier Operation.....	14
Connecting the CLA Amplifier to AC Mains.....	15
Rack Kit Installation.....	17
Specifications.....	18
230V AC Mains Power Specifications.....	29
Dimensional Drawings.....	33
Warranty & Service.....	34

# CLA SERIES

## COMMERCIAL LITE AMPLIFIERS

CLA804 / CLA404 / CLA802 / CLA402 / CLA202



## OWNER'S MANUAL

### INTRODUCTION:

Thank you for your purchase of the AtlasIED CLA Series amplifier. The CLA Series is a high-power amplifier designed for versatility, suitable for both commercial 25V/70V/100V distributed systems and professional applications requiring amplification for low impedance loads like 4Ω or 8Ω. Notably compact and lightweight compared to similar-performing models, the CLA Series incorporates Class D Output topology, offering the efficiency of a Class AB amplifier without compromising on sound quality.

The amplifier's power supply adopts a switch-mode, global auto-sensing design, ensuring a stable output even in fluctuating power conditions. The power supply and output stage are meticulously engineered to deliver exceptional dynamic high output voltage and current to virtually any loudspeaker load.

Key features of the CLA Series include rear panel detented level controls, remote level control, GPI control for standby low energy mode, priority mute, and balanced inputs. The amplifiers also boast a unique output stage with a low-resistance, direct-coupled thermal transfer design, effectively maintaining optimal temperature across all loads and output levels. Additionally, the CLA Series amplifiers are energy-efficient, meeting Energy Star standards and drawing only 1W of power in standby mode.

Whether your application involves a large distributed constant voltage sound system or a high SPL sound reinforcement system, the AtlasIED CLA Series stands as the solution for high-power and cost-effective amplification needs.

### AtlasIED AMPLIFIER POWER SHARE DESCRIPTION:

The AtlasIED Power Share feature is applicable to amplifiers with two channels of amplification, including 2 CH and 4 CH amplifiers, albeit controlled in pairs. Power Share enables the user to allocate a specified amount of audio amplified power to each channel. This allows for a deliberate imbalance where one amplifier channel can have more power than the other. Importantly, Power Share does not require any external devices like phones, tablets, or computers for configuration, nor does it rely on APP control software. The control for channel power is facilitated by a switch conveniently located on the amplifier.

In contrast to traditional amplifier designs where the power supply's maximum delivery is determined by the amplifier model's power rating, amplifiers with multiple channels that share a common power supply typically have fixed channel amplifier ratings. For example, a two-channel amp producing 200W per channel necessitates a 400W power supply. However, with AtlasIED Power Share technology, a 400W power supply can be configured using a switch. When selected, this switch configures the amplifier to allocate 350W of power to Channel 1 and 50W to Channel 2. The combined power of both channels still totals the maximum 400W from the power supply. Furthermore, individual channels can still be configured to deliver 200W each if desired.

### KEY FEATURES:

- CLA404 / CLA804 Four Amplifier Channels
- CLA202 / CLA402 / CLA802 Two Amplifier Channels
- Individual Channel Load Configurations of 2Ω, 4Ω, 8Ω, 25V, 70.7V, & 100V
- Power Share Per Two Channels (Patent Pending)
- Balanced Inputs
- Priority Mute
- Remote Level Control Per Channel
- Energy Savings Standby
- Rear Panel Attenuators
- Auto Sensing 100V - 240V~ AC Mains Power Supply
- Meets Energy Star Standards 1W Standby Mode
- Convection Cooling In Idle Mode, Fan Assist Under Signal



# CLA SERIES



## COMMERCIAL LITE AMPLIFIERS

CLA804 / CLA404 / CLA802 / CLA402 / CLA202



### OWNER'S MANUAL

#### IMPORTANT SAFETY INSTRUCTIONS

1. Read these instructions..
2. Keep these instructions.
3. Heed all warnings.
4. Follow all instructions.
5. Do not use this device near water.
6. Clean only with dry cloth.
7. Do not block any ventilation openings. Install in accordance with the manufacturer's instructions.
8. Do not install near any heat sources such as radiators, heat registers, stoves, or other device that produce heat.
9. Do not defeat the safety purpose of the polarized or grounding-type plug. A polarized plug has two blades with one wider than the other. A grounding type plug has two blades and a third grounding prong. The wide blade or the third prong are provided for your safety. If the provided plug does not fit into your outlet, consult an electrician for replacement of the obsolete outlet.
10. Protect the power cord from being walked on or pinched particularly at plugs, convenience receptacles, and the point where they exit from the device.
11. Only use attachments / accessories specified by the manufacturer.
12. Use only with the cart, stand, tripod, bracket, or table specified by the manufacturer, or sold with the device. When a cart is used, use caution when moving the cart / device combination to avoid injury from tip-over. 
13. Unplug this device during lightning storms or when unused for long periods of time.
14. Refer all servicing to qualified service personnel. Servicing is required when the device has been damaged in any way, such as power-supply cord or plug is damaged, liquid has been spilled, or objects have fallen into the device, the device has been exposed to rain or moisture, does not operate normally, or has been dropped.
15. This product is equipped with a three-wire grounding-type plug, a plug having a third (grounding) pin. This plug will only fit into a grounding-type power outlet. This is a safety feature. If you are unable to insert the plug into the outlet, contact your electrician to replace your obsolete outlet. Do not defeat the safety purpose of the grounding-type plug.
16. **WARNING:** To reduce the risk of fire or electric shock, this device should not be exposed to dripping, splashing, rain, or moisture, and objects filled with liquids, such as a vase, should not be placed on this device.
17. To completely disconnect this equipment from the mains, disconnect the power supply cord plug from the receptacle.
18. The mains plug of the power supply cord shall remain readily operable.
19. Protective earthing terminal. The apparatus should be connected  to a mains socket with a protective earthing connection.

#### CAUTION - SHOCK RISK



The lightning flash with arrowhead symbol within an equilateral triangle, is intended to alert the user to the presence of uninsulated "dangerous voltage" within the product's enclosure that may be of sufficient magnitude to constitute a risk of electric shock to persons.



The exclamation point within an equilateral triangle is intended to alert the user to the presence of important operating and maintenance (servicing) instructions in the literature accompanying the product.



**ATTENTION**

**CAUTION**

RISK OF ELECTRIC SHOCK  
DO NOT OPEN



**CAUTION**

WARNING: SHOCK HAZARD - DO NOT OPEN  
AVIS: RISQUE DE CHOC ÉLECTRIQUE - NE PAS OUVRIR

WARNING: TO REDUCE THE RISK OF FIRE OR ELECTRIC SHOCK  
DO NOT EXPOSE THIS EQUIPMENT TO RAIN OR MOISTURE

AVIS: NE PAS EXPOSER CE MATÉRIEL À LA PLUIE OU L'HUMIDITÉ  
AFIN DE RÉDUIRE LE RISQUE D'INFLAMMATION OU DE CHOC ÉLECTRIQUE



# CLA SERIES

## COMMERCIAL LITE AMPLIFIERS

CLA804 / CLA404 / CLA802 / CLA402 / CLA202



## OWNER'S MANUAL

### IMPORTANT SAFETY INSTRUCTIONS



#### WARNING - WHEN THE DEVICE IS IN USE:

- **WARNING:** For the terminals marked with symbol of ⚡ may be of sufficient magnitude to constitute a risk of electric shock. The external wiring connected to the terminals requires installation by an instructed person or the used of ready-made leads or cords.
- **WARNING:** The apparatus shall not be exposed to dripping or splashing and that objects filled with liquids, such as vases, shall not be placed on apparatus.
- **WARNING:** The mains plug is used as disconnect device, the disconnect device shall remain readily operable.
- To prevent electric shock, do not remove the product cover as there are high voltage components inside. Refer all servicing to AtlasIED.
- Should any of the following irregularities occur during use, immediately switch off the power, disconnect the power cord from the AC outlet and contact AtlasIED. Do not to attempt to continue operation with the product as this may cause fire or electric shock:
  - Smoke or strange smell coming from the unit.
  - If the product falls or the case is damaged.
  - If water or any metallic objects falls into the product.
  - If the power supply cord is damaged in any way.
  - If the unit is malfunctioning.
- Do not insert or drop metallic objects or flammable materials into the ventilation holes of the product's cover, as this may result in electric shock or fire.
- Do not place any containers with liquid or metallic objects on the top of the product. If any liquid spills into the unit, fire or electric shock may result.
- Never operate this product or touch the power supply cord during an electrical storm, electric shock may result.
- Never exceed the power rating on the product when connecting equipment. Fire and/or property damage may result
- Operate the product only with the voltage specified on the unit. Fire and/or electric shock may result if a higher voltage is used.
- Do not modify, kink, or cut the power cord. Do not place the power cord in close proximity to heaters and do not place heavy objects on the power cord, including the product itself, doing so may result in fire or electrical shock.
- Ensure that the safety ground terminal is connected to a proper ground. Never connect the ground to a gas pipe as a catastrophic disaster may result.
- Be sure the installation of the product is stable, avoid slanted surfaces as the product may fall and cause injury or property damage.



#### CAUTION - WHEN INSTALLING THE PRODUCT:

- Plugging in or unplugging the power cord with wet hands may result in electric shock.
- Never move the unit with the power cord plugged into the wall, as damage to the power cord may result.
- When unplugging the cord from the wall, grasp the plug, NOT the cord.
- Never install this product in humid or dusty locations, nor in direct sunlight, near sources of heat, or in areas where sooty smoke or steam are present. Fire and electric shock may result.
- Keep all sides of the unit at least 3 1/2" away from objects that may obstruct air flow to prevent the unit's internal temperature rise.



#### CAUTION - WHEN THE PRODUCT IS IN USE:

- Never place heavy objects on the product, causing it to fall and/or break, resulting in personal injury and property damage. In addition, the product itself may fall and cause injury and property damage.
- Contact AtlasIED for instructions on cleaning the inside of the unit. Large accumulations of dust inside the unit may result in heat buildup and fire.
- Ensure that the power supply plug is securely plugged into the wall outlet. Never allow dust to accumulate on the power plug or inside the wall outlet.
- When cleaning the unit or the unit is not to be operated for an extended period, unplug the power cord from the wall.



# CLA SERIES

## COMMERCIAL LITE AMPLIFIERS

CLA804 / CLA404 / CLA802 / CLA402 / CLA202



## OWNER'S MANUAL

### FRONT PANEL

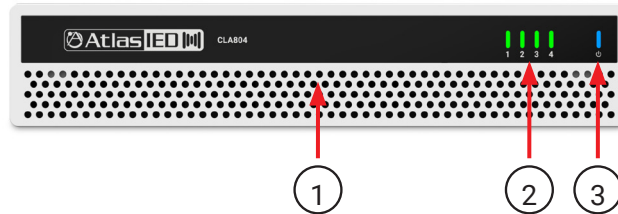

#### 1. VENTILATION / COOLING

The CLA amplifiers are equipped with fan-assist cooling, which functions by drawing cool air in from the front of the amp and expelling hot air through the rear and side panels. The cooling system of the CLA Series includes an idle mode with convection cooling and variable-speed fan assist cooling during amplification. Notably, the design of the CLA Series is such that air filters are not necessary. However, in environments with high levels of dust or dirt, occasional cleaning may be required to ensure optimal performance.

#### 2. CHANNEL STATUS INDICATORS

The CLA Channel Status indicator employs RGB LED technology to offer a visual indication of various conditions related to the channel's operation. Each channel has a separate indicator:

- A. Clear (Off) - The LED will not illuminate, indicating that the amplifier channel is stable and ready for use.
- B. Green (Blinking) - The LED will blink green when 25mV of input signal is applied to the amplifier.
- C. Yellow (Blinking) - The LED will blink yellow when the maximum amplifier output level is achieved.
- D. Red (Blinking) - The LED will blink red when the amp channel exceeds the maximum current settings, indicating a wrong load selection. Confirm that the load applied to the amp channel and the load switch selection match.  
Note: If one of the speaker outputs has a short, the amplifier will go into protect mode with all Channel LED's and the AC main LED blinking Red. The amplifier will try to reset itself every 20 seconds until the short has been removed.
- E. Red (Steady) - The LED will be steady red when the amp channel is in protect mode. Remove the speaker load from the amp channel, and if the LED turns off, look for a short in the speaker line. If the LED continues to illuminate and the speaker load is removed from the amp channel, contact AtlasIED Tech Support.
- F. Yellow (Steady) - The LED will be steady yellow when the channel is in a thermal protect condition. Once the thermal condition is resolved, the yellow LED turns off.

#### 3. AC MAINS & POWER SUPPLY STATUS INDICATOR

The CLA Power Supply Status indicator utilizes RGB LED technology to provide a visual indication of various conditions related to the incoming AC mains and the amplifier's power supply.

- A. Idle Mode (Blue Blinking) - The LED will blink blue indicating the amplifier is in a low power state. The fans are off during this state with the amplifier operating in convection cooling mode. The amplifier is ready to receive a signal and has no wake up delay
- B. Power On Mode (Blue Steady) - The LED will illuminate a steady blue state when proper AC mains power is applied to the amplifier, indicating that the amplifier is active and ready for use.
- C. Standby Mode (Yellow Steady) - A steady yellow state indicates Standby mode, where the amplifier's power supply is in Energy Save Mode, and the amplifier is not ready for use. To activate Standby mode, the rear panel remote activation control GPI must be triggered by shorting the (STB) and ground (G) pins together. In Standby mode, the CLA power consumption is less than 1 watt, and the amplifier will not pass audio.
- D. Protect Mode (Red Steady) - The LED will be steady red in the event of a fault condition with the power supply. If this occurs, unplug the amplifier from the AC mains and have the AC mains inspected by a qualified technician. If the AC power is stable, plug the CLA amplifier back in. If the LED remains red, contact AtlasIED Tech Support.
- E. AC Fault (Red Blinking) - The LED will blink red when there is low or high AC mains voltage, indicating a fault condition with the AC mains powering the amplifier. Under this condition, the amplifier will not function until the AC mains are within the amplifier's voltage requirements. CLA AC Mains operating voltage requirements are 100V – 132V and 208V - 240V.  
**Note:** If one of the speaker outputs has a short, the amplifier will go into protect mode with all Channel LED's and the AC main LED blinking Red. The amplifier will try to reset itself every 20 seconds until the short has been removed.
- F. Thermal Protection (Yellow Blinking) - This LED represents the temperature condition of the amplifier. It will blink yellow if the power supply's thermal protection is triggered, causing the power output to reduce. This allows the amplifier to cool down while still remaining functional.

# CLA SERIES

## COMMERCIAL LITE AMPLIFIERS

CLA804 / CLA404 / CLA802 / CLA402 / CLA202



### OWNER'S MANUAL

## REAR PANEL

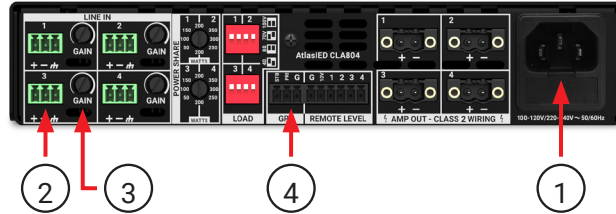

### 1. AC MAINS INPUT

The CLA Series is equipped with a global, wide-range AC Mains power supply that functions on 100V-120V and 220V-240V 50/60Hz power sources. The amplifiers feature an IEC-600320-C14 receptacle and come with a detachable 1.8-meter 14-gauge NEMA 5-15 power cord. Insert the IEC connector of the power cord into the IEC receptacle of the CLA Series amplifier, ensuring it is securely connected. For non-North American applications, refer to local electrical code requirements to select the appropriate power cord.

### 2. BALANCE INPUT

Connect balanced line level signals to the (+) (-) and (G) terminals. Note: If connecting an unbalanced line level input, short the (G) and (-) terminals together.

### 3. CHANNEL LEVEL CONTROLS

Each channel of the CLA amplifier features an independent detented level control. When either potentiometer is turned down (left or fully counterclockwise), no signal will come out of the corresponding amp channel. When turned up (right or fully clockwise), the amp will be set for maximum level.

### 4. GPI CONTROL PORT

The CLA GPI control port serves two functions:

- A. Standby Mode - Connect Pin 1 (STB) to Pin 3 (G) via a switch to activate Standby mode, muting all channels and placing the amplifier in Energy
- B. Save mode. When Standby is activated, the AC Mains Power LED illuminates a steady Yellow state, and power consumption is less than 1W.
- C. Switch requirements are low voltage and current SPST.
- D. Priority Mode - Connect Pin 2 (PRI) to Pin 3 (G) via switch to activate Priority mode, muting all inputs. Switch requirements are low voltage and current SPST. All Channel LED's will blink Red.

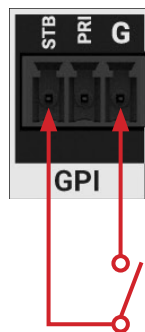

• Standby Mode



• Priority Mode

REAR PANEL - (CONTINUED ON NEXT PAGE)

# CLA SERIES

COMMERCIAL LITE AMPLIFIERS  
CLA804 / CLA404 / CLA802 / CLA402 / CLA202



## OWNER'S MANUAL

### REAR PANEL - (CONTINUED)

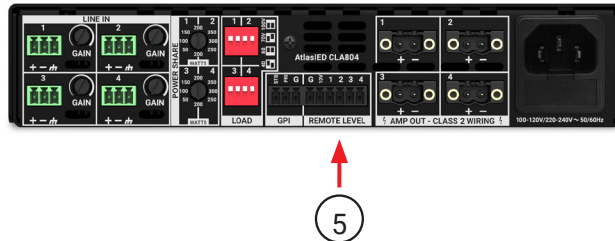

#### 5. REMOTE LEVEL CONTROL PORT

To enable remote control of the level on the CLA Series, you can use the Remote Level Control port. This control port operates on a 10KΩ based system, and it is recommended to use the optional AtlasIED WPD-VC10K wall control for this purpose. Follow these guidelines for proper setup:

- A. Recommended Control - It is recommended to use the optional AtlasIED WPD-VC10K wall control.
- B. System Configuration - Set the system's maximum levels using the amplifier level controls. Then, utilize the remote 10KΩ linear potentiometer as an attenuator.
- C. Wiring Requirements - Wiring the WPD-VC10K will require three-conductor unshielded wire, connecting the WPD terminals to the amplifier.
- D. Maximum Distance - The maximum distance for wiring can be up to 500 feet.
- E. Individual or Combined Control - Note that each channel of the CLA amplifier can be controlled individually or combined. Connect the "G" pin to the Low Z side of the pot and the 10V to the Hi Z side of the pot.
- F. Wiring Details - The wiper (P3 Below) of the pot should connect to the channel return pins labeled 1, 2, 3, or 4. When 10VDC is applied to the channel return pin, the amplifier will be at full power. Note: If the level control is not operating in the following manner with the level control is to the right (Fully Clockwise) the amplifier output is at maximum and with the level control is the left (Fully Counterclockwise) the +10V and the G are reversed.

Please ensure that the wiring is done using proper techniques and adhere to safety guidelines. If in doubt, consult the user manual or contact AtlasIED support for further assistance.

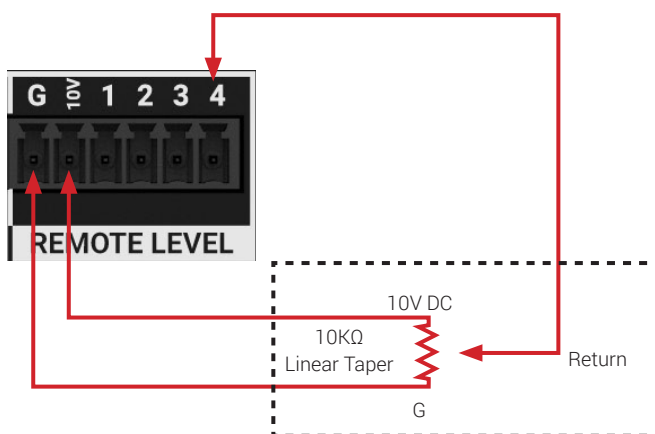

Single level control to one channel

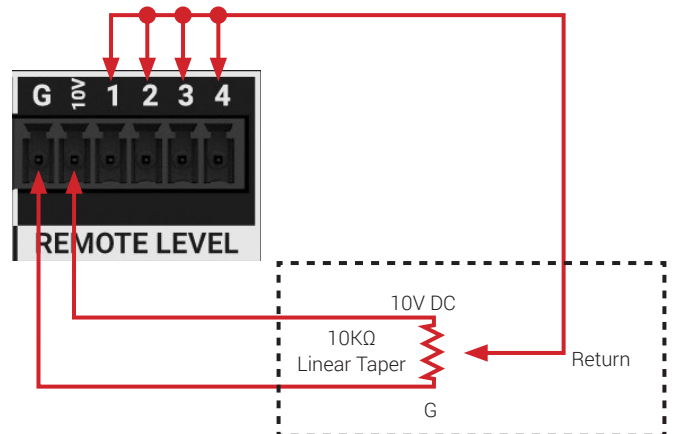

Single level control to multiple channels

REAR PANEL - (CONTINUED ON NEXT PAGE)



# CLA SERIES

## COMMERCIAL LITE AMPLIFIERS

CLA804 / CLA404 / CLA802 / CLA402 / CLA202



## OWNER'S MANUAL

### REAR PANEL - (CONTINUED)

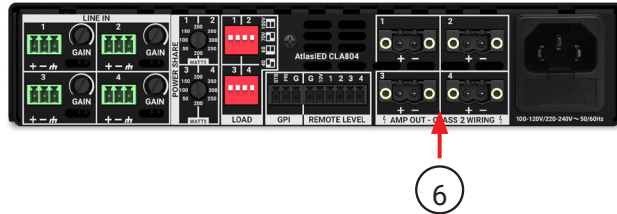

#### 6. LOUDSPEAKER CONNECTION

The CLA Series amplifiers are equipped with a locking Euro Block type connector. Please follow these guidelines when working with the connector, keeping safety in mind:

- A. Safety Precautions - Before starting the process, ensure that the amplifier is unplugged from the AC mains source to avoid potential high voltage electrical shock.
- B. Connector Details - The removable Euroblock connector is a 2-position, 5.08mm pitch design and is connected to the chassis by the 2 incorporated screws.
- C. Wire Gauge Recommendation - It is recommended to use 14-gauge wire or larger for connecting to the loudspeaker.
- D. Wire Size Acceptance - The terminals can accept wire sizes of 18-gauge to 12-gauge Class 3 wiring.
- E. Wire Preparation - Properly prepare the wire by stripping it back 0.250" (5mm). We do not recommend tinning (soldering the wire).
- F. Connection Process - Insert the wire into the terminal block slot and secure it by tightening the screws firmly. This step is critical to ensuring a secure connection for both safety and optimal audio quality.
- G. **Caution** - Failure to tighten the screws securely could lead to electrical shock or damage to the amplifier.

Always follow safety guidelines and manufacturer recommendations when working with audio equipment. If you have any doubts or concerns, consult the user manual or contact the manufacturer's support for clarification and assistance.

REAR PANEL - (CONTINUED ON NEXT PAGE)

# CLA SERIES

## COMMERCIAL LITE AMPLIFIERS

CLA804 / CLA404 / CLA802 / CLA402 / CLA202



### OWNER'S MANUAL

## REAR PANEL - (CONTINUED)

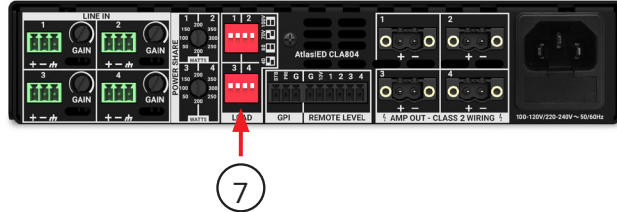

### 7. AMPLIFIER LOAD CONFIGURATION SWITCHES - IMPORTANT!

The CLA Amp series provides flexibility in configuring load requirements, allowing independent load selections for each channel. Each channel can be configured for 2Ω, 4Ω, 8Ω, 25V, 70V, and 100V loads. Two Dip Switches dedicated to each specific channel are used for configuring the amplifier channels' load selections.

- A. Safety Precautions - Before starting the process, ensure that the amplifier is unplugged from the AC mains source to avoid potential high voltage electrical shock.
- B. Connector Details - The removable Euroblock connector is a 2-position, 5.08mm pitch design and is connected to the chassis by the 2 incorporated screws.
- C. Wire Gauge Recommendation - It is recommended to use 14-gauge wire or larger for connecting to the loudspeaker.
- D. Wire Size Acceptance - The terminals can accept wire sizes of 18-gauge to 12-gauge Class 3 wiring.
- E. Wire Preparation - Properly prepare the wire by stripping it back 0.250" (5mm). We do not recommend tinning (soldering the wire).
- F. Connection Process - Insert the wire into the terminal block slot and secure it by tightening the screws firmly. This step is critical to ensuring a secure connection for both safety and optimal audio quality.
- G. **Caution** - Failure to tighten the screws securely could lead to electrical shock or damage to the amplifier. Always follow safety guidelines and manufacturer recommendations when working with audio equipment. If you have any doubts or concerns, consult the user manual or contact the manufacturer's support for clarification and assistance.

**Important Note:** Failure to choose the proper setting for the load applied may cause the amplifier to go into protect mode.

#### Dip Switch Configuration:

- DIP SWITCH #1 & #2: Channel 1 Load Selection
- DIP SWITCH #3 & #4: Channel 2 Load Selection

#### Channel 1 Load Selection Switch Positions:

- 100V: DP SW #1 UP & #2 UP
- 70V: DP SW #1 UP & #2 DOWN
- 8Ω: DP SW #1 DOWN & #2 DOWN
- 4Ω: DP SW #1 DOWN & #2 UP

**Note:** For 2Ω loads or 25V systems, use 4Ω switch settings. Refer to the power specifications for power ratings corresponding to the selected load. By following the provided chart and ensuring the correct Dip Switch positions, you can tailor the amplifier's load configuration to suit your specific needs. Always refer to the user manual for additional details and specifications.

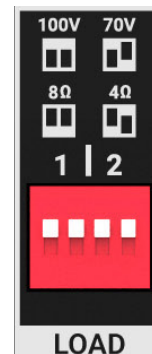

# CLA SERIES

## COMMERCIAL LITE AMPLIFIERS

CLA804 / CLA404 / CLA802 / CLA402 / CLA202



### OWNER'S MANUAL

## REAR PANEL - (CONTINUED)

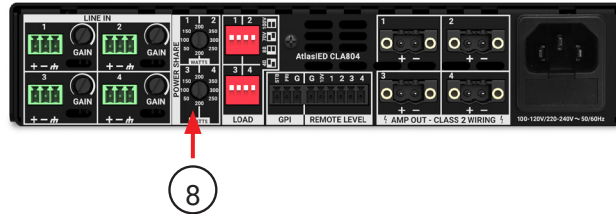

### 8. POWER SHARE SELECTION

The Power Share rotary switch in the CLA Amp series allows you to direct the amplifier's power between two channels. The number of Power Share rotary switches depends on the amplifier model: CLA402 / CLA202 2-channel amps have one Power Share switch, while CLA804 / CLA404 4-channel amps have two Power Share switches.

- A. Power Supply and Channels - For every two amplifier channels, there is one dedicated power supply, each with a maximum power delivery in watts.
- B. Power Share Operations - Power Share enables you to direct the power between channels by selecting the power level using the Power Share rotary switch.
- C. Switch Indication - The Power Share switch has a double arrow indicator to show the power selection between the two channels.
- D. Example - CLA402 - The CLA402, being a two-channel amp, has a single 400W power supply shared between CH 1 & CH 2. If the Power Share switch is set at 200W for CH 1 and 200W for CH 2, each channel receives an equal 200W. Rotating the switch one click to the right may result in CH 2 getting 350W and CH 1 receiving 50W, while the total power between both channels remains 400W. Importantly, the load selection does not affect the Power Share selection.

Always refer to the user manual for detailed instructions on using the Power Share feature specific to your amplifier model. The double arrow indicator and clear labeling on the switch assist in visualizing the power distribution between channels.

#### E. Power Share Selection Examples

- **Fig 1** - CLA402 Power Share selections arrow pointer is set to 200W for CH 1 / CH 2
- **Fig 2** - CLA804 Power Share selection arrow is set to 200W CH 1 / CH 2 and 200W for CH 3 / CH 4
- **Fig 3** - CLA202 Power Share selections arrow pointer is set to 100W for CH 1 / CH 2
- **Fig 4** - CLA404 Power Share selection arrow is set to 100W CH 1 / CH 2 and 100W for CH 3 / CH 4
- **Fig 5** - CLA802 Power Share selection arrow pointer is 400W CH 1 / CH 2

**Note:** Power Share selections are not affected by the load selections.

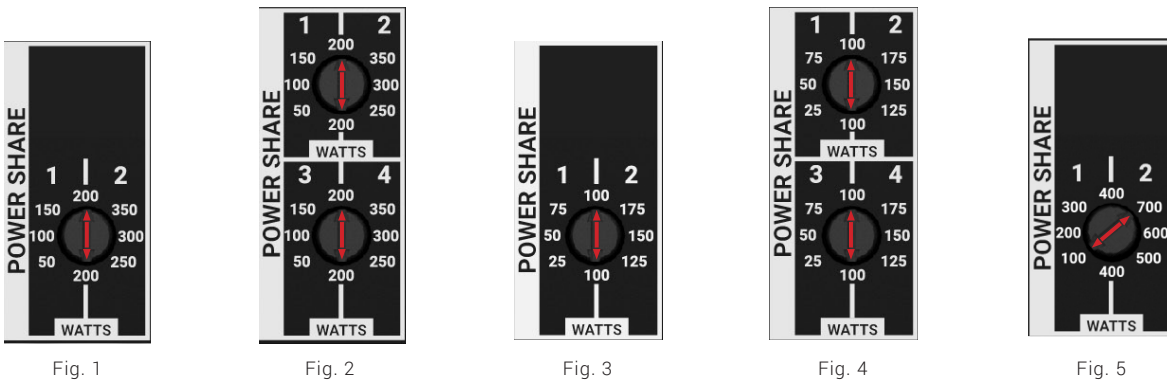

REAR PANEL - (CONTINUED ON NEXT PAGE)

# CLA SERIES

## COMMERCIAL LITE AMPLIFIERS

CLA804 / CLA404 / CLA802 / CLA402 / CLA202



### OWNER'S MANUAL

#### REAR PANEL - (CONTINUED)

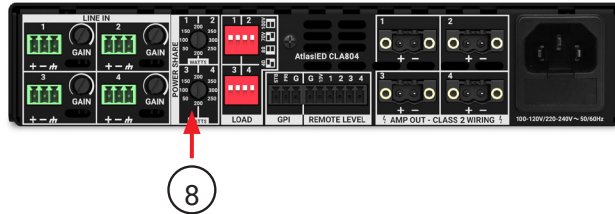

This example below shows the Power Share Selection can be different between channels

- **Fig 6** - CLA402 Power Share selections arrow pointer is set to CH 1 50W (70V) / CH 2 350W (4Ω)
- **Fig 7** - CLA804 Power Share selection arrow is set to CH 1 50W (100V) / CH 2 350W (8Ω) and CH 3 50W (100V) / CH 4 350W (8Ω)
- **Fig 8** - CLA202 Power Share selections arrow pointer is set to CH 1 50W (70V) / CH 2 150W (4Ω)
- **Fig 9** - CLA404 Power Share selection arrow is set to CH 1 25W (70V) / CH 2 175W (70V) and CH 3 75W (70V) / CH 4 125W (70V)

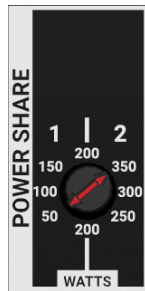

Fig. 6

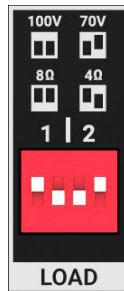

Fig. 7

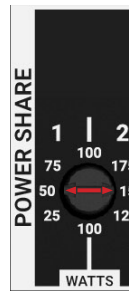

Fig. 8

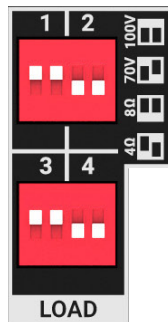

Fig. 9



# CLA SERIES

## COMMERCIAL LITE AMPLIFIERS

CLA804 / CLA404 / CLA802 / CLA402 / CLA202



## OWNER'S MANUAL

### CABLING

The CLA amplifier can be used with either balanced or unbalanced sources, and the outputs can be used with either balanced or unbalanced loads, provided the proper cabling is used. A balanced line is defined as a two-conductor shielded cable with the two center conductors carrying the same signal but of opposite polarity when referenced to ground.

An unbalanced line is generally a single-conductor shielded cable with the center conductor carrying the signal and the shield at ground potential.

**Balanced Input** - AtlasIED recommends using either 20-gauge or 22-gauge two-conductor wire with shield for low level signals. Maintain the proper polarity, (+) to (+), (-) to (-), and shield to ground. Note: The ground center pin of the Phoenix connector is common for both channels.

**Loudspeaker Outputs** - Use Class 2, 2 conductor unshielded wire of the appropriate gauge. Contact AtlasIED technical support at 1-800-876-3333 with questions regarding wire gauge. The number of loudspeakers connected, and their tap settings will be required for technical support to properly recommend wire.

### PLACEMENT OF THE AMP

Turn off all equipment before making connections. Install the amplifier in a standard-width 19" rack. It can be mounted above or below anything that does not generate excessive heat. Although the unit's chassis is shielded against radio frequency and electromagnetic interference, extremely high fields of RF and EMI should be avoided.

**Ventilation** - The appliance should be situated so that its location or position does not interfere with proper ventilation. For example, the CLA amplifier should not be situated in a sealed cabinet or on a shelf with obstacles on it that may impede the flow of air through the ventilation openings. It is recommended that it be rack mounted into an equipment rack.

**Heat** - The CLA amplifier should be situated away from heat sources such as radiators, heat registers, stoves, or other appliances (including amplifiers) that produce excessive heat. Ambient temperatures should not exceed 95° F (35°C) when equipment is in use.

### CLA GAIN vs INPUT SENSITIVITY

Gain is the input voltage to obtain a specific output voltage, not the amount of current or watts. The power delivered by an amplifier is determined by the load and the voltage applied across it. Input sensitivity is the amount of input voltage required to an amplifier to reach full output.

### LOW Z-GAIN

The gain settings for the 8-Ω and 4-Ω mode change with each Power Share power level setting. This design ensures that full power output is achieved when a 1V signal is applied, regardless of the Power Share selection. While this approach is not typical in amplifier designs, it is necessary due to the 16 variations available for each channel. Maintaining a consistent input sensitivity across different load types and power level selections is the only way to achieve uniform calibration between zones and amplifier channels.

### HIGH Z-GAIN

The gain remains consistent for all 70V or 100V Power Share settings to achieve the same output voltage of 70V, while the load changes to accommodate different power levels.

### LO Z & HIGH Z-GAIN

The gain is different between Low Z (Lo Z) and High Z (Hi Z) because it requires significantly more signal to achieve a 100V output compared to a 4-Ω output. If all the gains were the same, it would take approximately three times the input signal for a 100V output compared to that for a 4-Ω load. The CLA804 gain is 29dB 4-Ω, 32dB 8-Ω, 37dB 70V, 40dB 100V.



# CLA SERIES

## COMMERCIAL LITE AMPLIFIERS

CLA804 / CLA404 / CLA802 / CLA402 / CLA202



## OWNER'S MANUAL

### CLA AMPS 2-Ω OPERATION

The CLA amplifier is indeed versatile, designed for both high-voltage and high-current demands, making it adaptable to both distributed 100V systems and low-impedance setups down to 2Ω. In distributed systems, where an amplifier needs to output 70V or 100V to drive multiple speakers over long distances, it's a challenge for low-power amplifiers (under 200W) to step up the voltage. The CLA amplifiers tackle this by maintaining voltage at these high levels effectively.

For low-impedance systems (2Ω, 4Ω, or 8Ω) the amp delivers high current. While the voltage demands are lower, the amplifier's Class D output stage ensures stable, efficient current delivery for 8Ω and 4Ω loads and can handle 2Ω loads as well. Power availability for 2Ω is contingent on the power supply available current. 2Ω loads require twice the current of a 4Ω load. Hence, the specification is conservatively rated, yet in practical applications, the delivered power at 2Ω often surpasses these figures. For 2Ω setups, use the 4Ω settings. The CLA will auto sense 2Ω loads.

### CLA AMPS 25V OPERATION

In a 25V distributed audio system, the current requirements are significantly higher compared to systems operating at 70V or 100V. 25 system can be considered a low impedance audio system, where the power and voltage required results in lower impedance loads being applied to the amplifier.

For example, if you have 20 25V speakers tapped at 10W each, the total power requirement from the amplifier would be 200W at 25V. To determine the load impedance applied to the amplifier, you can use Ohm's Law. The formula is:  $V^2 \div \text{Power} = Z$  ( $25v \times 25v = 625$ ,  $625 \div 200W = 3.1\Omega$ ). This is the load applied to the amplifier.

For optimal performance in 25V systems, the CLA loads switch should be set to 4Ω. The CLA amplifiers are designed to auto-sense the load within an impedance range. However, if the power requirement exceeds 200W, the load impedance will drop below 2Ω, which will limit the amplifier's power output. This is why models CLA402 & CLA404 reduce power from 400W to 200W for 25V applications.



# CLA SERIES

## COMMERCIAL LITE AMPLIFIERS

CLA804 / CLA404 / CLA802 / CLA402 / CLA202



### OWNER'S MANUAL

## CONNECTING THE CLA AMPLIFIER TO AC MAINS

### DO NOT DO!

- **Never** plug a CLA Series amplifier into a circuit without knowing what other products are connected to the same circuit.
- **Never** plug a CLA Series amplifier into a power strip. Always connect directly to a dedicated circuit wall receptacle. Power strips are not designed to deliver high amounts of continuous or peak current.
- **Never** plug an CLA Series amplifier into an extension cord.

CLA (Commercial Lite Amps) require special attention to AC power

Know the type of outlet you are going to use and never use an adapter!

#### Correct Outlet

120V - 20 Amp (NEMA5-20r)



#### Correct Outlet

120V - 15 Amp



#### Warning! Do Not Use

120V - 15 Amp to 20 Amp plug adapter



### NEVER DO THIS

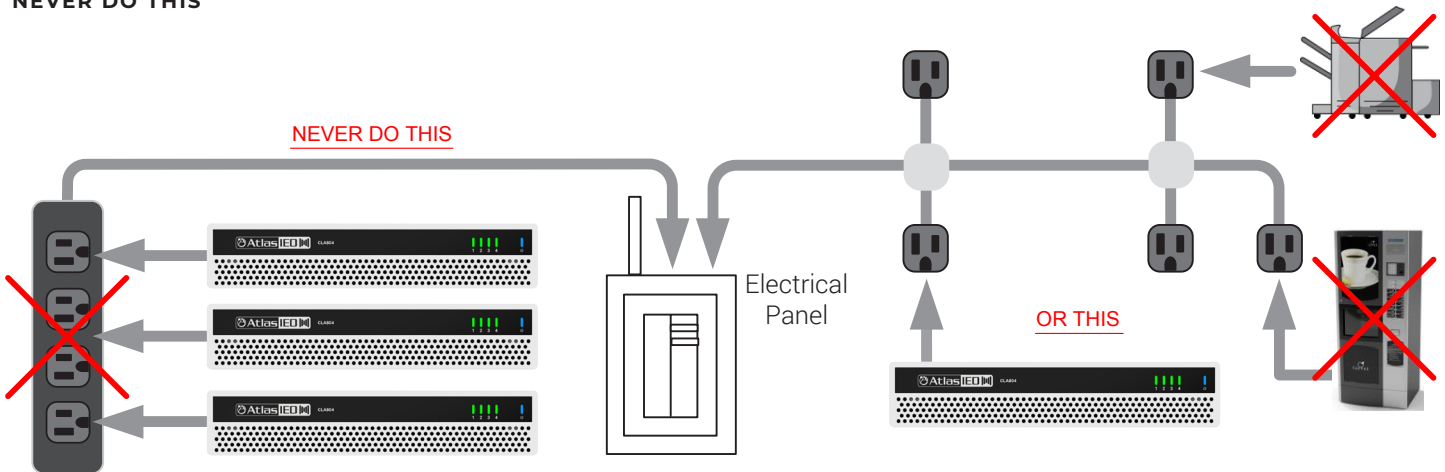

This example shows 3 x CLA amplifiers plugged into a power distribution strip in an amp rack. This shares the loads of all three amplifiers on one 15A circuit. CLA amplifiers require a separate circuit for each amplifier to operate properly.

This example shows a CLA amplifier plugged into an existing branch circuit in a building. Using this circuit to power a CLA amplifier is a bad practice because you can't be sure how long the wire run is or how many loads are on the circuit. Branch circuits are designed for random use by peripheral devices and should never be used for AV system devices, especially CLA amplifiers.

CONNECTING THE CLA AMPLIFIER TO AC MAINS - (CONTINUED ON NEXT PAGE)

# CLA SERIES

## COMMERCIAL LITE AMPLIFIERS

CLA804 / CLA404 / CLA802 / CLA402 / CLA202



### OWNER'S MANUAL

## CONNECTING THE CLA AMPLIFIER TO AC MAINS - (CONTINUED)

### BEST PRACTICES

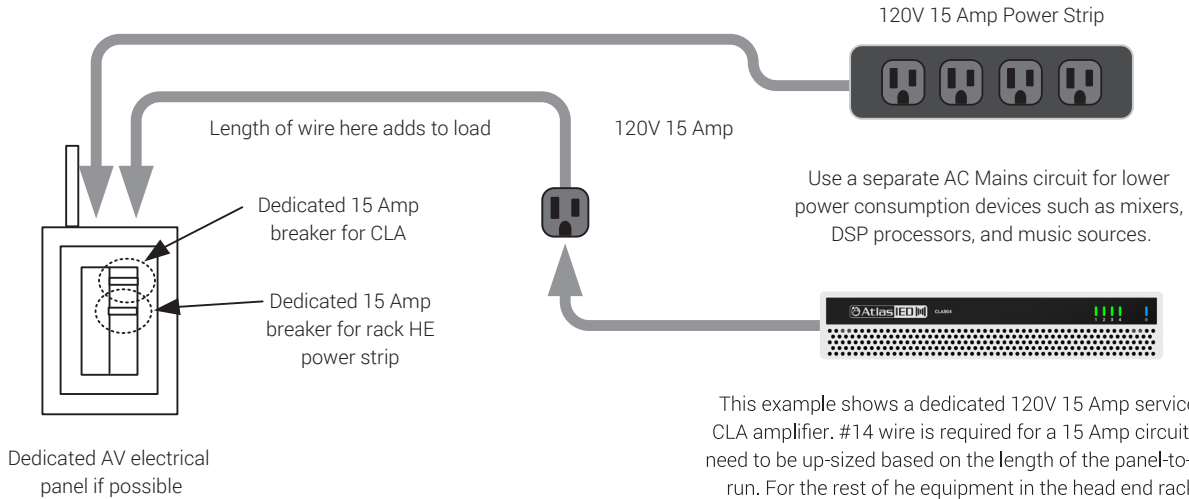



# CLA SERIES

## COMMERCIAL LITE AMPLIFIERS

CLA804 / CLA404 / CLA802 / CLA402 / CLA202



## OWNER'S MANUAL

### RACK KIT INSTALLATION

The CLA Series amplifier can be rack mounted as a single amp or side by side with any other AtlasIED ½ rack model. All parts to rack mount single or two amps are included with the CLA amp. Depending on the rack mounting method there may be extra part left; disregard them. Follow the illustrations below for kit assembly.

#### Kit Contains:

- Rack Ears Short, Qty 2
- Rack Ear to Chassis Screws M3 x 10mm, Qty 4
- Rack Ear Long for Single Unit Mounting, Qty 1
- Top & Bottom Chassis Joiner Plates, Qty 4
- 4-40 x 3/8 Flat Head Black Screws to Secure Joiner Plate to Chassis, Qty 16
- 10/32 x 1" Rack Mount Screws, Qty 4
- 10/32 Screw Plastic Washer, Qty 4

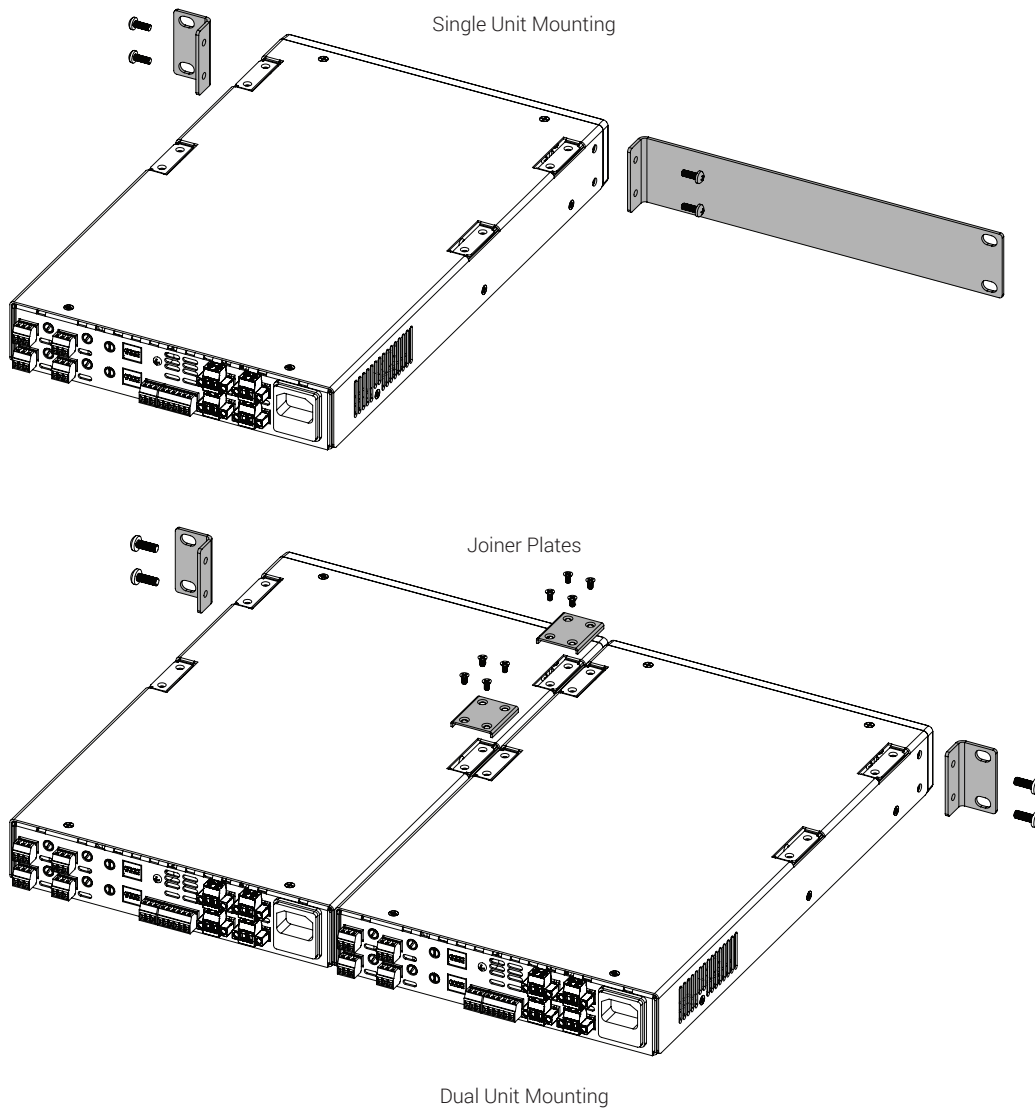

# CLA SERIES

## COMMERCIAL LITE AMPLIFIERS

CLA804 / CLA404 / CLA802 / CLA402 / CLA202



### OWNER'S MANUAL

System	
Type	2-Channel / 4-Channel Power Amplifier
Power Supply Type	Switch Mode - Wide Range 90 - 132V / 208 - 264V
Amp Topology	Class D
Number of Fixed Inputs	2 for CLA202, CLA402, CLA802, 4 for CLA404, CLA804
DSP Internal	No
Network	No
Optional Card Slot	No

Output Power (Note 1) Total Power Available 200W	CLA202			
Power Share Configuration	100W / 100W	175W / 25W	150W / 50W	125W / 75W
4Ω, 8Ω, 70.7V, 100V	100W / 100W	175W / 25W	150W / 50W	125W / 75W
25V x 4 CH (Note 7)	2 x 100W	150W / 25W	150W / 50W	125W / 75W
2Ω x 4 CH (Note 8)	2 x 50W	90W / 12W	75W / 25W	65W / 38W

Output Power (Note 1) Total Power Available 400W	CLA402			
Power Share Configuration	200W / 200W	350W / 50W	300W / 100W	250W / 150W
4Ω, 8Ω, 70.7V, 100V	200W / 200W	350W / 50W	300W / 100W	250W / 150W
25V x 4 CH (Note 7)	2 x 150W	150W / 50W	150W / 100W	150W / 150W
2Ω x 4 CH (Note 8)	2 x 100W	175W / 25W	150W / 50W	125W / 75W

Output Power (Note 1) Total Power Available 800W	CLA802			
Power Share Configuration	400W / 400W	700W / 100W	600W / 200W	500W / 300W
4Ω, 8Ω, 70.7V, 100V	400W / 400W	700W / 100W	600W / 200W	500W / 300W
25V x 2 CH (Note 7)	2 x 200W	300W / 100W	300W / 150W	250W / 150W
2Ω x 2 CH (Note 8)	2 x 200W	350W / 50W	300W / 100W	250W / 150W

Output Power (Note 1) Total Power Available 400W	CLA404			
Power Share Configuration	100W / 100W x 2	175W / 25W x 2	150W / 50W x 2	125W / 75W x 2
4Ω, 8Ω, 70.7V, 100V	100W / 100W x 2	175W / 25W x 2	150W / 50W x 2	125W / 75W x 2
25V x 4 CH (Note 7)	4 x 100W	150W / 25W x 2	150W / 50W x 2	125W / 75W x 2
2Ω x 4 CH (Note 8)	4 x 50W	90W / 12W x 2	75W / 25W x 2	65W / 38W x 2



# CLA SERIES

## COMMERCIAL LITE AMPLIFIERS

CLA804 / CLA404 / CLA802 / CLA402 / CLA202



### OWNER'S MANUAL

Output Power (Note 1) Total Power Available 800W		CLA804		
Power Share Configuration	200W / 200W x 2	350W / 50W x 2	300W / 100W x 2	250W / 150W x 2
4Ω, 8Ω, 70.7V, 100V	200W / 200W x 2	350W / 50W x 2	300W / 100W x 2	250W / 150W x 2
25V x 4 CH (Note 7)	4 x 150W	150W / 50W x 2	150W / 100W x 2	150W / 150W x 2
2Ω x 4 CH (Note 8)	4 x 100W	175W / 25W x 2	150W / 50W x 2	125W / 75W x 2

Factory Default Settings (As Shipped)	
Amplifier Configuration	2 CH & 4 CH
Level Controls	Rear Panel
Control Ports (Rear Panel)	Standby OFF, Priority Mute OFF
Load Configurations	70V
Power Share Configuration	CLA202 = 100W x 100W x 1, CLA402 = 200W x 200W x 1, CLA802 = 400W x 400W x 1, CLA404 = 100W x 100W x 2, CLA804 = 200W x 200W x 2

Inputs	
Input Quantity	Input Quantity 2-Balanced Inputs for CLA202 and CLA402, 4-Balanced Inputs for CLA404 and CLA804
Input Type	Balanced Line
Input Connectors Type	3.5mm Euro Block
Input Impedance	20KΩ (Balanced) 10KΩ (Unbalanced)
Input Sensitivity	1V (Fixed)
Maximum Input Level dBu & Vrms	20dBu

Level Control	
Rear Panel	Rotary Detented Attenuators



# CLA SERIES

## COMMERCIAL LITE AMPLIFIERS

CLA804 / CLA404 / CLA802 / CLA402 / CLA202



### OWNER'S MANUAL

#### Status Indicator - AC Mains / Power Supply, Multi-Color

Idle Mode	Blue Blinking
Power On Mode	Blue Steady
Standby Mode	Yellow Steady
Protect Mode	Red Steady
AC Fault	Red Blinking
Thermal Protection	Yellow Blinking

#### Channel Status Indicators - 1 Per Channel, Multi-Color

Ready for Use	Clear (Off)
Input Signal	Green
Output Limit	Yellow Flashing
Output Protect	Red Steady
Over Current / Fault	Red
Thermal Protection	Yellow Steady

#### GPIO Ports (Rear Panel)

Number of Ports	Qty 5 for CLA202 and CLA402, Qty 7 for CLA404 and CLA804
Type of Connector	Euro Block 3.5mm
Standby (Energy Save Mode)	Contact Closure Enables Standby
Priority Mute	Contact Closure Enables All Channel Mute
Remote Level	Each Channel Has Remote Mute Port

#### Configuration Settings (Rear Panel)

Gain (Level)	Rotary Pot
Power Share	Rotary Switch

#### Output Terminals (Speaker)

Output Connectors Type	Removable Euro Block, 5.08mm Pitch, Locking
Output Connectors Quantity	2 Position, Qty 2 CLA202 and CLA402, Qty 4 CLA404 and CLA804
Wire Size	30-12 Gauge (Class 2 Wire)
Current Rating	12A RMS per Terminal

#### Electrical Specifications (General)

Total Harmonic Distortion 1 kHz and 1 dB Below Rated Power	≤0.15%
Signal to Noise Ratio 8Ω	>93dBA Below Rated Output (A-Weighted)
Frequency Response	20Hz - 20kHz (+0/-1.5dB) 2,4, 8-Ω, 25V Mode, 50Hz - 20KHz (+0/-1.5dB) 70V & 100V Mode
Input Impedance Balanced (Nominal)	100Ω Balanced Line to Line

# CLA SERIES

## COMMERCIAL LITE AMPLIFIERS

CLA804 / CLA404 / CLA802 / CLA402 / CLA202



### OWNER'S MANUAL

Input Sensitivity	0.775V
Slew Rate	>18V/ $\mu$ s
Damping Factor (20Hz to 400Hz)	>250
Gain	CLA202 and CLA404 26dB 4 $\Omega$ , 29dB 8 $\Omega$ , 37dB 70V, 40dB 100V, CLA802 26dB 4 $\Omega$ , 29dB 8 $\Omega$ , 37dB 70V, 40dB 100V, CLA402 and CLA804 29dB 4 $\Omega$ , 32dB 8 $\Omega$ , 37dB 70V, 40dB 100V
Crosstalk CH 1-2 & CH 2-1	>70dB
Max Voltage Per Output 100V Setting	101V
Max Current Per Output 4 $\Omega$ Setting	CLA202 and CLA404 9.4A @ 175W / CLA402 and CLA804 13.2A @ 350W
Protection	Soft Start, Input RF, DC, Short Circuit, Current Overload, Clip Limit, AC Mains Under / Over Voltage Shut Off, Peak Current Limit, Over Temp

#### Cooling

Cooling System	Idle Mode is Convection, Audio Signal Sense (Fan, Variable with Temperature)
Cooling Air Flow Direction	Rear to Front, No Filters
Fan Noise Idle 1M	0dBu (Fan is Off)
Fan Noise Max 1M	42dBu

#### Environmental

Operating Temperature	10° - 104°F (-12° - 40°C)
Relative Humidity	0 - 95%, Non Condensing

#### AC Power Requirements

Operating Voltage	90V - 132V / 208V - 264V 50/60Hz, Auto Voltage Sense
Mains Interface	IEC C14
Power Cord (Included)	1.8m, IEC C13 to NEMA 5-15 Plug, 16AWG
Minimum Power-Up Voltage	90V
Maximum Operating Voltage	264V



# CLA SERIES

## COMMERCIAL LITE AMPLIFIERS

CLA804 / CLA404 / CLA802 / CLA402 / CLA202



### OWNER'S MANUAL

Power Consumption / Current Draw @ 120V AC Mains, Power Share Settings 100W x 2	CLA202		
	Amps	Watts	BTU / hr (Note 4)
Standby Mode, Meets Energy Star Standards	0.02A	0.4W	1.36 BTU
Low Power Mode, Note 9	0.1A	10W	34 BTU
Idle Active	0.3A	18.6W	63 BTU
Average Power 2Ω, All CH Driven, Note 2, 8	0.6A	41W	139 BTU
Average Power 4Ω, All CH Driven, Note 2	0.5A	36W	122 BTU
Average Power 8Ω, All CH Driven, Note 2	0.5A	33W	112 BTU
Average Power 25V, All CH Driven, Note 2,7	0.5A	36W	122 BTU
Average Power 70V, All CH Driven, Note 2	0.4A	26W	88 BTU
Average Power 100V, All CH Driven, Note 2	0.4A	27W	92 BTU
Pink Noise Power 2Ω, All CH Driven, Note 3, 8	1.8A	170W	580 BTU
Pink Noise Power 4Ω, All CH Driven, Note 3	1.9A	180W	614 BTU
Pink Noise Power 8Ω, All CH Driven, Note 3	1.8A	171W	583 BTU
Pink Noise Power 25V, All CH Driven, Note 3, 8	1.8A	164W	559 BTU
Pink Noise Power 70V, All CH Driven, Note 3	1.6A	125W	426 BTU
Pink Noise Power 100V, All CH Driven, Note 3	1.6A	129W	440 BTU
Burst Power 2Ω, All CH Driven, Note 4, 8	1.3A	90W	307 BTU
Burst Power 4Ω, All CH Driven, Note 4	1.3A	91W	310 BTU
Burst Power 8Ω, All CH Driven, Note 4	1.3A	83W	283 BTU
Burst Power 25V, All CH Driven, Note 4, 7	1.3A	85W	290 BTU
Burst Power 70V, All CH Driven, Note 4	1.1A	77W	262 BTU
Burst Power 100V, All CH Driven, Note 4	1.1A	75W	255 BTU
Music Power 2Ω, All CH Driven, Note 5, 8	2.1A	198W	675 BTU
Music Power 4Ω, All CH Driven, Note 5	2.1A	203W	692 BTU
Music Power 8Ω, All CH Driven, Note 5	2.1A	203W	692 BTU
Music Power 25V, All CH Driven, Note 6, 8	2.1A	203W	692 BTU
Music Power 70V, All CH Driven, Note 5	1.9A	191W	651 BTU
Music Power 100V, All CH Driven, Note 5	1.8A	187W	638 BTU
Sine Wave Power 2Ω, All CH Driven, Note 6, 8	3.2A	236W	805 BTU
Sine Wave Power 4Ω, All CH Driven, Note 6	3.5A	265W	904 BTU
Sine Wave Power 8Ω, All CH Driven, Note 6	3.4A	248W	846 BTU
Sine Wave Power 25V, All CH Driven, Note 6, 7	3.4A	250W	853 BTU
Sine Wave Power 70V, All CH Driven, Note 6	2.9A	220W	750 BTU
Sine Wave Power 100V, All CH Driven, Note 6	2.9A	223W	760 BTU



# CLA SERIES

## COMMERCIAL LITE AMPLIFIERS

CLA804 / CLA404 / CLA802 / CLA402 / CLA202



### OWNER'S MANUAL

Power Consumption / Current Draw @ 120V AC Mains, Power Share Settings 200W x 2	CLA402		
	Amps	Watts	BTU / hr (Note 4)
Standby Mode, Meets Energy Star Standards	0.02A	0.4W	1.36 BTU
Low Power Mode, Note 9	0.1A	10W	34 BTU
Idle Active	0.2A	11.7W	39 BTU
Average Power 2Ω, All CH Driven, Note 2, 8	0.5A	37W	126 BTU
Average Power 4Ω, All CH Driven, Note 2	0.8A	68W	232 BTU
Average Power 8Ω, All CH Driven, Note 2	0.8A	65W	221 BTU
Average Power 25V, All CH Driven, Note 2,7	0.7A	62W	211 BTU
Average Power 70V, All CH Driven, Note 2	0.7A	57W	194 BTU
Average Power 100V, All CH Driven, Note 2	0.7A	57W	194 BTU
Pink Noise Power 2Ω, All CH Driven, Note 3, 8	2.1A	189W	644 BTU
Pink Noise Power 4Ω, All CH Driven, Note 3	3.1A	251W	856 BTU
Pink Noise Power 8Ω, All CH Driven, Note 3	3.1A	248W	846 BTU
Pink Noise Power 25V, All CH Driven, Note 3, 8	2.9A	233W	795 BTU
Pink Noise Power 70V, All CH Driven, Note 3	3.0A	243W	829 BTU
Pink Noise Power 100V, All CH Driven, Note 3	3.0A	240W	818 BTU
Burst Power 2Ω, All CH Driven, Note 4, 8	1.0A	125W	426 BTU
Burst Power 4Ω, All CH Driven, Note 4	1.4A	172W	586 BTU
Burst Power 8Ω, All CH Driven, Note 4	1.2A	139W	474 BTU
Burst Power 25V, All CH Driven, Note 4, 7	1.4A	170W	580 BTU
Burst Power 70V, All CH Driven, Note 4	1.1A	133W	453 BTU
Burst Power 100V, All CH Driven, Note 4	1.1A	126W	429 BTU
Music Power 2Ω, All CH Driven, Note 5, 8	3.5A	295W	1006 BTU
Music Power 4Ω, All CH Driven, Note 5	4.4A	368W	1255 BTU
Music Power 8Ω, All CH Driven, Note 5	4.4A	368W	1255 BTU
Music Power 25V, All CH Driven, Note 6, 8	4.2A	346W	1180 BTU
Music Power 70V, All CH Driven, Note 5	4.2A	355W	1211 BTU
Music Power 100V, All CH Driven, Note 5	4.2A	351W	1197 BTU
Sine Wave Power 2Ω, All CH Driven, Note 6, 8	4.5A	362W	1235 BTU
Sine Wave Power 4Ω, All CH Driven, Note 6	5.5A	457W	1559 BTU
Sine Wave Power 8Ω, All CH Driven, Note 6	5.5A	442W	1508 BTU
Sine Wave Power 25V, All CH Driven, Note 6, 7	5.2A	428W	1460 BTU
Sine Wave Power 70V, All CH Driven, Note 6	4.9A	405W	1381 BTU



# CLA SERIES

## COMMERCIAL LITE AMPLIFIERS

CLA804 / CLA404 / CLA802 / CLA402 / CLA202



### OWNER'S MANUAL

Power Consumption & Current Draw @ 120V AC Mains, Power Share Settings 400W x 2	CLA802		
	Amp	Watts	BTU / hr (Note 4)
Standby Mode, Meets Energy Star Standards	0.02A	0.5W	1.7
Low Power Mode - Note: 9	0.18A	10W	34
Idle Active	0.24A	14W	47
Average Power 2Ω, All CH Driven, Note 2, 8	1.09A	85W	290
Average Power 4Ω, All CH Driven, Note 2	0.90A	67W	228
Average Power 8Ω, All CH Driven, Note 2	0.82A	61W	208
Average Power 25V, All CH Driven, Note 2,7	0.85A	63W	214
Average Power 70V, All CH Driven, Note 2	0.82A	61W	208
Average Power 100V, All CH Driven, Note 2	0.80A	59W	201
Pink Noise Power 2Ω, All CH Driven, Note 3, 8	2.91A	234W	798
Pink Noise Power 4Ω, All CH Driven, Note 3	2.76A	228W	777
Pink Noise Power 8Ω, All CH Driven, Note 3	2.65A	216W	737
Pink Noise Power 25V, All CH Driven, Note 3, 8	2.62A	216W	737
Pink Noise Power 70V, All CH Driven, Note 3	2.70A	225W	767
Pink Noise Power 100V, All CH Driven, Note 3	2.30A	192W	655
Burst Power 2Ω, All CH Driven, Note 4, 8	1.80A	184W	627
Burst Power 4Ω, All CH Driven, Note 4	1.83A	191W	651
Burst Power 8Ω, All CH Driven, Note 4	1.77A	185W	631
Burst Power 25V, All CH Driven, Note 4, 7	1.75A	182W	621
Burst Power 70V, All CH Driven, Note 4	1.68A	180W	614
Burst Power 100V, All CH Driven, Note 4	1.67A	178W	607
Music Power 2Ω, All CH Driven, Note 5, 8	5.01A	420W	1433
Music Power 4Ω, All CH Driven, Note 5	5.10A	448W	1528
Music Power 8Ω, ALL CH Driven, Note 5	5.03A	440W	1502
Music Power 25V, All CH Driven, Note 6, 8	5.03A	432W	1474
Music Power 70V, All CH Driven, Note 5	5.04A	435W	1484
Music Power 100V, All CH Driven, Note 5	4.96A	425W	1450
Sine Wave Power 2Ω, All CH Driven, Note 6, 8	10.20A	935W	3190
Sine Wave Power 4Ω, All CH Driven, Note 6	10.82A	947W	3231
Sine Wave Power 8Ω, All CH Driven, Note 6	10.53A	889W	3033
Sine Power 25V, All CH Driven, Note 6, 7	10.70A	928W	3166
Sine WavePower 70V, All CH Driven, Note 6	10.30A	938W	3200
Sine WavePower 100V, All CH Driven, Note 6	10.12A	878W	2995





# CLA SERIES

## COMMERCIAL LITE AMPLIFIERS

CLA804 / CLA404 / CLA802 / CLA402 / CLA202



### OWNER'S MANUAL

Power Consumption / Current Draw @ 120V AC Mains, Power Share Settings 100W x 4	CLA404		
	Amps	Watts	BTU / hr (Note 4)
Standby Mode, Meets Energy Star Standards	0.02A	0.4W	1.36 BTU
Low Power Mode, Note 9	0.1A	10W	34 BTU
Idle Active	0.4A	21W	71 BTU
Average Power 2Ω, All CH Driven, Note 2, 8	1.1A	82W	279 BTU
Average Power 4Ω, All CH Driven, Note 2	1.1A	85W	290 BTU
Average Power 8Ω, All CH Driven, Note 2	1.1A	83W	283 BTU
Average Power 25V, All CH Driven, Note 2,7	1.1A	82W	279 BTU
Average Power 70V, All CH Driven, Note 2	1.0A	78W	266 BTU
Average Power 100V, All CH Driven, Note 2	1.0A	77W	262 BTU
Pink Noise Power 2Ω, All CH Driven, Note 3, 8	3.2A	293W	999 BTU
Pink Noise Power 4Ω, All CH Driven, Note 3	3.9A	336W	1146 BTU
Pink Noise Power 8Ω, All CH Driven, Note 3	3.9A	325W	1108 BTU
Pink Noise Power 25V, All CH Driven, Note 3, 8	3.9A	330W	1126 BTU
Pink Noise Power 70V, All CH Driven, Note 3	3.8A	323W	1102 BTU
Pink Noise Power 100V, All CH Driven, Note 3	3.6A	316W	1178 BTU
Burst Power 2Ω, All CH Driven, Note 4, 8	1.3A	137W	467 BTU
Burst Power 4Ω, All CH Driven, Note 4	1.5A	155W	528 BTU
Burst Power 8Ω, All CH Driven, Note 4	1.5A	148W	504 BTU
Burst Power 25V, All CH Driven, Note 4, 7	1.5A	150W	511 BTU
Burst Power 70V, All CH Driven, Note 4	1.4A	141W	481 BTU
Burst Power 100V, All CH Driven, Note 4	1.4A	139W	474 BTU
Music Power 2Ω, All CH Driven, Note 5, 8	4.1A	338W	1153 BTU
Music Power 4Ω, All CH Driven, Note 5	4.2A	347W	1184 BTU
Music Power 8Ω, All CH Driven, Note 5	4.2A	347W	1184 BTU
Music Power 25V, All CH Driven, Note 6, 8	4.0A	322W	1098 BTU
Music Power 70V, All CH Driven, Note 5	4.1A	339W	1156 BTU
Music Power 100V, All CH Driven, Note 5	4.1A	334W	1139 BTU
Sine Wave Power 2Ω, All CH Driven, Note 6, 8	5.4A	468W	1596 BTU
Sine Wave Power 4Ω, All CH Driven, Note 6	5.9A	483W	1579 BTU
Sine Wave Power 8Ω, All CH Driven, Note 6	5.8A	475W	1620 BTU
Sine Wave Power 25V, All CH Driven, Note 6, 7	5.8A	470W	1603 BTU
Sine Wave Power 70V, All CH Driven, Note 6	5.1A	411W	1402 BTU
Sine Wave Power 100V, All CH Driven, Note 6	5.2A	427W	1456 BTU



# CLA SERIES

## COMMERCIAL LITE AMPLIFIERS

CLA804 / CLA404 / CLA802 / CLA402 / CLA202



### OWNER'S MANUAL

Power Consumption / Current Draw @ 120V AC Mains, Power Share Settings 200W x 4	CLA804		
	Amps	Watts	BTU / hr (Note 4)
Standby Mode, Meets Energy Star Standards	0.02A	0.4W	1.36 BTU
Low Power Mode, Note 9	0.1A	10W	34 BTU
Idle Active	0.35A	18W	61BTU
Average Power 2Ω, All CH Driven, Note 2, 8	0.9A	83W	283 BTU
Average Power 4Ω, All CH Driven, Note 2	1.4A	108W	368 BTU
Average Power 8Ω, All CH Driven, Note 2	1.1A	95W	324 BTU
Average Power 25V, All CH Driven, Note 2,7	1.2A	98W	334 BTU
Average Power 70V, All CH Driven, Note 2	1.2A	96W	327 BTU
Average Power 100V, All CH Driven, Note 2	1.2A	98W	334 BTU
Pink Noise Power 2Ω, All CH Driven, Note 3, 8	1.85A	179W	611 BTU
Pink Noise Power 4Ω, All CH Driven, Note 3	3.35A	235W	801 BTU
Pink Noise Power 8Ω, All CH Driven, Note 3	2.47A	208W	734 BTU
Pink Noise Power 25V, All CH Driven, Note 3, 8	3.08A	215W	738 BTU
Pink Noise Power 70V, All CH Driven, Note 3	3.2A	227W	774 BTU
Pink Noise Power 100V, All CH Driven, Note 3	3.2A	225W	767 BTU
Burst Power 2Ω, All CH Driven, Note 4, 8	1.30A	138W	470 BTU
Burst Power 4Ω, All CH Driven, Note 4	1.67A	162W	552 BTU
Burst Power 8Ω, All CH Driven, Note 4	1.26A	131W	446 BTU
Burst Power 25V, All CH Driven, Note 4, 7	1.62A	160W	545 BTU
Burst Power 70V, All CH Driven, Note 4	1.71A	168W	168 BTU
Burst Power 100V, All CH Driven, Note 4	1.60A	157W	535 BTU
Music Power 2Ω, All CH Driven, Note 5, 8	4.85A	390W	1330 BTU
Music Power 4Ω, All CH Driven, Note 5	4.97A	425W	1450 BTU
Music Power 8Ω, All CH Driven, Note 5	4.97A	425W	1450 BTU
Music Power 25V, All CH Driven, Note 6, 8	4.50A	396W	1351 BTU
Music Power 70V, All CH Driven, Note 5	4.5A	406W	1385 BTU
Music Power 100V, All CH Driven, Note 5	4.5A	403W	1375 BTU
Sine Wave Power 2Ω, All CH Driven, Note 6, 8	10.1A	835W	2849 BTU
Sine Wave Power 4Ω, All CH Driven, Note 6	12.1A	971W	3313 BTU
Sine Wave Power 8Ω, All CH Driven, Note 6	9.8A	822W	2822 BTU
Sine Wave Power 25V, All CH Driven, Note 6, 7	10.3A	830W	2832 BTU
Sine Wave Power 70V, All CH Driven, Note 6	9.8A	802W	2736 BTU
Sine Wave Power 100V, All CH Driven, Note 6	9.6A	789W	2692 BTU



# CLA SERIES

## COMMERCIAL LITE AMPLIFIERS

CLA804 / CLA404 / CLA802 / CLA402 / CLA202



### OWNER'S MANUAL

Package Content	CLA202	CLA402	CLA 802	CLA404	CLA804
Power Cord IEC C13 Plug / 16AWG 1.8m Cord / NEMA 5-15 Plug	Qty 1	Qty 1	Qty 1	Qty 1	Qty 1
Input Connector, 3 Position, 3.5mm Pitch	Qty 2	Qty 2	Qty 2	Qty 4	Qty 4
GPI Connector, 3 Position, 3.5mm Pitch	Qty 1	Qty 1	Qty 1	Qty 1	Qty 1
Remote Level Connector, 4 Position, 3.5mm Pitch	Qty 1	Qty 1	Qty 1	Qty 0	Qty 0
Remote Level Connector, 6 Position, 3.5mm Pitch	Qty 0	Qty 0	Qty 0	Qty 1	Qty 1
Speaker Connector, 2 Position, 5.08mm Pitch	Qty 2	Qty 2	Qty 2	Qty 4	Qty 4
Rack Kit for Single & Dual Mounting	Qty 1	Qty 1	Qty 1	Qty 1	Qty 1
Install Sheet with QR Code	Qty 1	Qty 1	Qty 1	Qty 1	Qty 1

Dimensions and Weight	CLA202	CLA402	CLA802	CLA404	CLA804
Rack Mount Requirements (All Models)	½ Rack 8.5"				
Dimensions - Unit (All Models)	W 8.5" x H 1.75" x D 13.77" (216mm x 44mm x 350mm)				
Dimensions - Shipping (All Models)	W 17.25" x H 4.5" x D 11.75" (438mm x 114mm x 298mm)				
Weight - Unit	6.5 lbs. / 3.0 kg	7 lbs. / 3.2 kg.	7.61 lbs. / 3.46 kg.	8 lbs. / 3.64 kg.	7.8 lbs. / 3.55 kg.
Weight - Shipping	11.25 lbs. / 5.1 kg.	11.75 lbs. / 5.34 kg.	12.35 lbs. / 5.6 kg.	12.75 lbs. / 5.8 kg.	12.25 lbs. / 5.55 kg.

Agency Approvals	
North America Agency	TUV
Testing Standard North America	62368-1
FCC Class A (Conducted & Radiated Emissions)	Part 15 B of the FCC Rules
RoHS / WEEE Compliant	Yes
CE	Yes



# CLA SERIES

## COMMERCIAL LITE AMPLIFIERS

CLA804 / CLA404 / CLA802 / CLA402 / CLA202



## OWNER'S MANUAL

### NOTES:

1. Power Level - Test is defined as follows: 1kHz sine wave signal burst of 20 cycles (20ms) at 1% THD+N, followed by 480 cycles of a 1kHz sine wave at 10% of the max power. Other power measurements available upon request. All power tests are done at 120V.
2. Average power draw is defined as Pink Noise input signal applied to achieve 1/4 of the 4Ω or 70.7V power rating.
3. Max pink noise power current draw is defined as Pink Noise applied as the signal source to the amplifier to achieve 100% of the 4Ω or 70.7V power rating. Using Pink Noise for testing amplifiers is a strenuous test that provides a consistent signal across the entire audio spectrum. Pink noise also provides a 6db Crest factor signal that injects a balance of RMS and peak signals providing realistic amp draw data for audio application.
4. Max burst power draw is defined as follows: 1 kHz sine wave signal burst of 20 cycles (40ms) at 100% of the 4Ω or 70.7V power rating., followed by 480 cycles of a 1 kHz sine wave at 10% of the max power repeated. Note: The amp draw /watt data is the peak power consumed and not steady state amp draw. This complies the UL 62368-1 standard and testing for maximum peak amp draw for a 120v 15A AC mains.
5. Music power draw is defined as dynamic input signal applied to achieve the maximum rated power into a 4Ω or 70.7V load. This test also represents realistic current draw data for audio applications. The current draw data is the maximum peak amp / watt and not steady state amp draw. This complies the UL 62368-1 standard and testing for maximum peak amp draw for a 120V 15A AC mains. Note When specifying this amp for power consumption, we recommend using the Max Music Power Amps / Watt rating data.
6. Sine wave power draw is defined as 1 KHz input signal applied to achieve the maximum power output before clip into a 4Ω or 70.7V load. This data should be used as a reference of the maximum of the current the amplifier can draw. The amount of time used to test was subject to exceeding the units circuit breaker provides this data thermal trip point. Note: The HPA2408 is designed and to be specified for paging and music program application. Steady state sine wave signals over 3 seconds should not be applied and may drip a 15A 120V AC Mains breaker.
7. 25V System use 4 Ohm Load Selection Settings, CLA402 & CLA804 Power Share 200W Setting Equal 150W, CLA202 & CLA404 Power Share Setting 100W Equal 100W.
8. 2-ohm loads use 4 Ohm Load Selection Settings, CLA402 & CLA804 Power Share 200W Setting Equal 100W, CLA202 & CLA404 Power Share 100W Setting Equal 50W.
9. Low Power Mode: The Front panel AC Mains indicator will blink Blue slowly. Fans are off and the power rails are lowered reducing power consumption. Signal flow is not interrupted or delayed.



# CLA SERIES

## COMMERCIAL LITE AMPLIFIERS

CLA804 / CLA404 / CLA802 / CLA402 / CLA202



### OWNER'S MANUAL

Power Consumption / Current Draw @ 230V AC Mains, Power Share Settings 100W x 2		CLA202		
	Amps	Watts	BTU / hr (Note 4)	
Standby Mode	0.02A	0.5W	1.7 BTU	
Low Power Mode, Note 9	0.1A	10W	34 BTU	
Idle Active	0.2A	18W	61 BTU	
Average Power 2Ω, All CH Driven, Note 2, 8	0.3A	36W	122 BTU	
Average Power 4Ω, All CH Driven, Note 2	0.4A	45W	153 BTU	
Average Power 8Ω, All CH Driven, Note 2	0.4A	42W	143 BTU	
Average Power 100V, All CH Driven, Note 2	0.3A	31W	105 BTU	
Pink Noise Power 2Ω, All CH Driven, Note 3, 8	1.4A	160W	545 BTU	
Pink Noise Power 4Ω, All CH Driven, Note 3	1.5A	173W	590 BTU	
Pink Noise Power 8Ω, All CH Driven, Note 3	1.4A	168W	573 BTU	
Pink Noise Power 100V, All CH Driven, Note 3	1.0A	112W	382 BTU	
Burst Power 2Ω, All CH Driven, Note 4, 8	0.9A	102W	348 BTU	
Burst Power 4Ω, All CH Driven, Note 4	0.9A	105W	358 BTU	
Burst Power 8Ω, All CH Driven, Note 4	0.8A	92W	313 BTU	
Burst Power 100V, All CH Driven, Note 4	0.8A	90W	307 BTU	
Music Power 2Ω, All CH Driven, Note 5, 8	1.5A	194W	661 BTU	
Music Power 4Ω, All CH Driven, Note 5	1.5A	197W	672 BTU	
Music Power 8Ω, All CH Driven, Note 5	1.5A	197W	672 BTU	
Music Power 100V, All CH Driven, Note 5	1.1A	109W	371 BTU	
Sine Wave Power 2Ω, All CH Driven, Note 6, 8	1.9A	250W	853 BTU	
Sine Wave Power 4Ω, All CH Driven, Note 6	1.9A	251W	856 BTU	
Sine Wave Power 8Ω, All CH Driven, Note 6	1.8A	243W	829 BTU	
Sine Wave Power 100V, All CH Driven, Note 6	1.6A	226W	771 BTU	

Power Consumption / Current Draw @ 230V AC Mains, Power Share Settings 200W x 2		CLA402		
	Amps	Watts	BTU / hr (Note 4)	
Standby Mode	0.03A	0.5W	1.7 BTU	
Low Power Mode, Note 9	0.1A	9W	30 BTU	
Idle Active	0.1A	18W	61 BTU	
Average Power 2Ω, All CH Driven, Note 2, 8	0.4A	45W	153 BTU	
Average Power 4Ω, All CH Driven, Note 2	0.5A	58W	197 BTU	
Average Power 8Ω, All CH Driven, Note 2	0.5A	56W	191 BTU	
Average Power 100V, All CH Driven, Note 2	0.4A	48W	163 BTU	
Pink Noise Power 2Ω, All CH Driven, Note 3, 8	1.0A	133W	453 BTU	

# CLA SERIES

## COMMERCIAL LITE AMPLIFIERS

CLA804 / CLA404 / CLA802 / CLA402 / CLA202



### OWNER'S MANUAL

Pink Noise Power 4Ω, All CH Driven, Note 3	1.7A	247W	842 BTU
Pink Noise Power 8Ω, All CH Driven, Note 3	1.6A	238W	812 BTU
Pink Noise Power 100V, All CH Driven, Note 3	1.5A	231W	788 BTU
Burst Power 2Ω, All CH Driven, Note 4, 8	0.9A	156W	532 BTU
Burst Power 4Ω, All CH Driven, Note 4	1.1A	185W	631 BTU
Burst Power 8Ω, All CH Driven, Note 4	1.1A	182W	621 BTU
Burst Power 100V, All CH Driven, Note 4	0.9A	141W	481 BTU
Music Power 2Ω, All CH Driven, Note 5, 8	2.0A	298W	1016 BTU
Music Power 4Ω, All CH Driven, Note 5	2.2A	332W	1132 BTU
Music Power 8Ω, All CH Driven, Note 5	2.2A	332W	1132 BTU
Music Power 100V, All CH Driven, Note 5	2.1A	318W	1085 BTU
Sine Wave Power 2Ω, All CH Driven, Note 6, 8	2.3A	362W	1235 BTU
Sine Wave Power 4Ω, All CH Driven, Note 6	2.9A	451W	1538 BTU
Sine Wave Power 8Ω, All CH Driven, Note 6	2.8A	445W	1518 BTU
Sine Wave Power 100V, All CH Driven, Note 6	2.5A	391W	1334 BTU

Power Consumption & Current Draw @ 230V AC Mains, Power Share Settings 400W x 2	CLA802		
	Amps	Watts	BTU / hr (Note 4)
Standby Mode	0.03A	0.5W	1.7
Low Power Mode - Note: 9	0.10A	10W	34
Idle Active	0.14A	14W	47
Average Power 2, All CH Driven, Note 2, 8	0.65A	77W	262
Average Power 4Ω, All CH Driven, Note 2	0.51A	61W	208
Average Power 8Ω, All CH Driven, Note 2	0.42A	55W	187
Average Power 100V, All CH Driven, Note 2	0.40A	53W	180
Pink Noise Power 2Ω, All CH Driven, Note 3, 8	1.92A	290W	989
Pink Noise Power 4Ω, All CH Driven, Note 3	1.71A	228W	777
Pink Noise Power 8Ω, All CH Driven, Note 3	1.60A	215W	733
Pink Noise Power 100V, All CH Driven, Note 3	1.35A	178W	607
Burst Power 2Ω, All CH Driven, Note 4, 8	1.16A	167W	569
Burst Power 4W, All CH Driven, Note 4	1.27A	185W	631
Burst Power 8Ω, All CH Driven, Note 4	1.22A	181W	617
Burst Power 8Ω, All CH Driven, Note 4	1.22A	181W	617
Burst Power 100V, All CH Driven, Note 4	1.22A	180W	614
Music Power 2Ω, All CH Driven, Note 5, 8	2.94A	403W	1375
Music Power 4W, All CH Driven, Note 5	2.80A	378W	1289

# CLA SERIES

## COMMERCIAL LITE AMPLIFIERS

CLA804 / CLA404 / CLA802 / CLA402 / CLA202



### OWNER'S MANUAL

Music Power 8Ω, All CH Driven, Note 5, 8	2.94A	403W	1375
Music Power 100V, All CH Driven, Note 5	2.65A	356W	1214
Sine Wave Power 2Ω, All CH Driven, Note 6, 8	5.41A	837W	2855
Sine Wave Power 4Ω, All CH Driven, Note 6	5.65A	891W	3040
Sine Wave Power 8Ω, All CH Driven, Note 6	5.57A	856W	2920
Sine Wave Power 100V, All CH Driven, Note 6	5.15A	823W	2808

Power Consumption / Current Draw @ 230V AC Mains, Power Share Settings 100W x 4	CLA404		
	Amps	Watts	BTU / hr (Note 4)
Standby Mode	0.03A	0.5W	1.7 BTU
Low Power Mode, Note 9	0.1A	9W	30 BTU
Idle Active	0.2A	18W	61 BTU
Average Power 2Ω, All CH Driven, Note 2, 8	0.6A	85W	290 BTU
Average Power 4Ω, All CH Driven, Note 2	0.6A	84W	286 BTU
Average Power 8Ω, All CH Driven, Note 2	0.6A	82W	279 BTU
Average Power 100V, All CH Driven, Note 2	0.5A	71W	242 BTU
Pink Noise Power 2Ω, All CH Driven, Note 3, 8	2.0A	286W	975 BTU
Pink Noise Power 4Ω, All CH Driven, Note 3	2.1A	298W	1016 BTU
Pink Noise Power 8Ω, All CH Driven, Note 3	2.1A	295W	1006 BTU
Pink Noise Power 100V, All CH Driven, Note 3	1.9A	274W	934 BTU
Burst Power 2Ω, All CH Driven, Note 4, 8	1.1A	128W	436 BTU
Burst Power 4Ω, All CH Driven, Note 4	1.2A	142W	484 BTU
Burst Power 8Ω, All CH Driven, Note 4	1.2A	136W	464 BTU
Burst Power 100V, All CH Driven, Note 4	1.0A	113W	385 BTU
Music Power 2Ω, All CH Driven, Note 5, 8	1.2A	140W	477 BTU
Music Power 4Ω, All CH Driven, Note 5	2.8A	387W	1320 BTU
Music Power 8Ω, All CH Driven, Note 5	2.8A	387W	1320 BTU
Music Power 100V, All CH Driven, Note 5	2.4A	335W	1143 BTU
Sine Wave Power 2Ω, All CH Driven, Note 6, 8	3.4A	528W	1801 BTU
Sine Wave Power 4Ω, All CH Driven, Note 6	3.2A	469W	1600 BTU
Sine Wave Power 8Ω, All CH Driven, Note 6	3.1A	462W	1576 BTU
Sine Wave Power 100V, All CH Driven, Note 6	2.8A	414W	1412 BTU

# CLA SERIES

## COMMERCIAL LITE AMPLIFIERS

CLA804 / CLA404 / CLA802 / CLA402 / CLA202



### OWNER'S MANUAL

Power Consumption / Current Draw @ 230V AC Mains, Power Share Settings 200W x 4	CLA804		
	Amps	Watts	BTU / hr (Note 4)
Standby Mode	0.03A	0.6W	2 BTU
Low Power Mode, Note 9	0.1A	9W	30 BTU
Idle Active	0.16A	18W	61 BTU
Average Power 2Ω, All CH Driven, Note 2, 8	0.48A	62W	211 BTU
Average Power 4Ω, All CH Driven, Note 2	0.58A	76W	259 BTU
Average Power 8Ω, All CH Driven, Note 2	0.52A	68W	232 BTU
Average Power 100V, All CH Driven, Note 2	0.62A	79W	269 BTU
Pink Noise Power 2Ω, All CH Driven, Note 3, 8	0.95A	118W	402 BTU
Pink Noise Power 4Ω, All CH Driven, Note 3	1.68A	248W	846 BTU
Pink Noise Power 8Ω, All CH Driven, Note 3	1.35A	197W	672 BTU
Pink Noise Power 100V, All CH Driven, Note 3	1.65A	235W	801 BTU
Burst Power 2Ω, All CH Driven, Note 4, 8	0.96A	137W	467 BTU
Burst Power 4Ω, All CH Driven, Note 4	1.59A	182W	621 BTU
Burst Power 8Ω, All CH Driven, Note 4	1.28A	154W	425 BTU
Burst Power 100V, All CH Driven, Note 4	1.42A	168W	573 BTU
Music Power 2Ω, All CH Driven, Note 5, 8	2.60A	334W	1139 BTU
Music Power 4Ω, All CH Driven, Note 5	2.68A	362W	1235 BTU
Music Power 8Ω, All CH Driven, Note 5	2.68A	362W	1235 BTU
Music Power 100V, All CH Driven, Note 5	2.54A	336W	1146 BTU
Sine Wave Power 2Ω, All CH Driven, Note 6, 8	4.76A	711W	2426 BTU
Sine Wave Power 4Ω, All CH Driven, Note 6	5.53A	855W	2917 BTU
Sine Wave Power 8Ω, All CH Driven, Note 6	4.98A	728W	2449 BTU
Sine Wave Power 100V, All CH Driven, Note 6	5.12A	778W	2654 BTU



# CLA SERIES

## COMMERCIAL LITE AMPLIFIERS

CLA804 / CLA404 / CLA802 / CLA402 / CLA202



## OWNER'S MANUAL

### DIMENSIONAL DRAWINGS

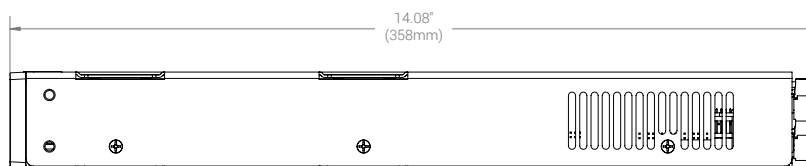
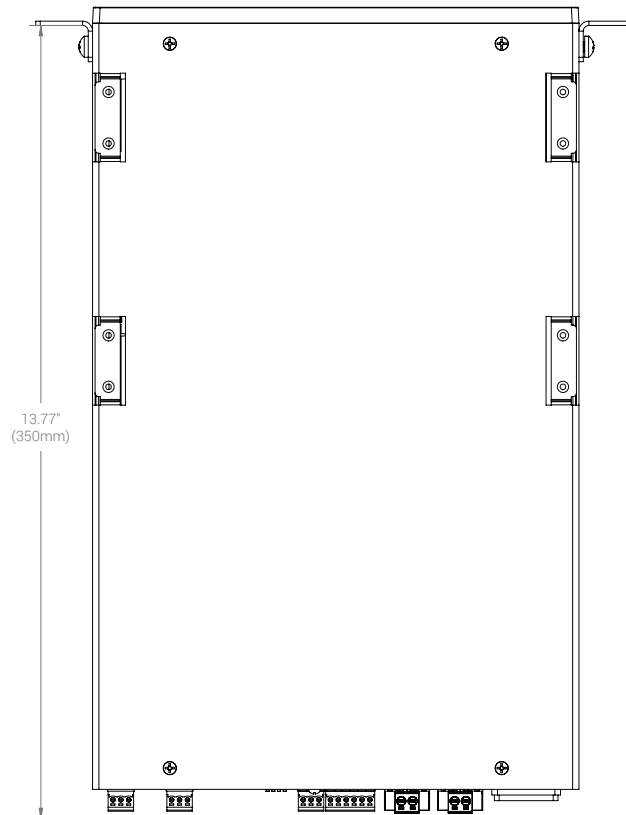
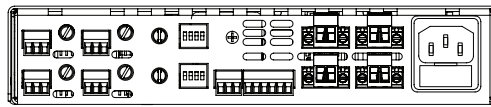
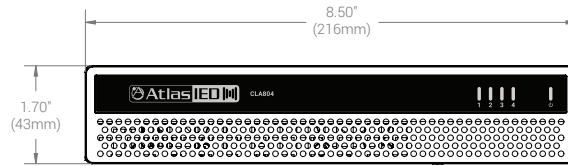

# CLA SERIES

## COMMERCIAL LITE AMPLIFIERS

CLA804 / CLA404 / CLA802 / CLA402 / CLA202



## OWNER'S MANUAL

### LIMITED WARRANTY

All products manufactured by AtlasIED are warranted to the original dealer / installer, industrial or commercial purchaser to be free from defects in material and workmanship and to be in compliance with our published specifications, if any. This warranty shall extend from the date of purchase for a period of three years on all AtlasIED products, including SOUNDOLIER brand, and ATLAS SOUND brand products except as follows: one year on electronics and control systems; one year on replacement parts; and one year on Musician Series stands and related accessories. Additionally, fuses and lamps carry no warranty. AtlasIED will solely at its discretion, replace at no charge or repair free of charge defective parts or products when the product has been applied and used in accordance with our published operation and installation instructions. We will not be responsible for defects caused by improper storage, misuse (including failure to provide reasonable and necessary maintenance), accident, abnormal atmospheres, water immersion, lightning discharge, or malfunctions when products have been modified or operated in excess of rated power, altered, serviced or installed in other than a workman like manner. The original sales invoice should be retained as evidence of purchase under the terms of this warranty. All warranty returns must comply with our returns policy set forth below. When products returned to AtlasIED do not qualify for repair or replacement under our warranty, repairs may be performed at prevailing costs for material and labor unless there is included with the returned product(s) a written request for an estimate of repair costs before any nonwarranty work is performed. In the event of replacement or upon completion of repairs, return shipment will be made with the transportation charges collect.

EXCEPT TO THE EXTENT THAT APPLICABLE LAW PREVENTS THE LIMITATION OF CONSEQUENTIAL DAMAGES FOR PERSONAL INJURY, ATLASIED SHALL NOT BE LIABLE IN TORT OR CONTRACT FOR ANY DIRECT, CONSEQUENTIAL OR INCIDENTAL LOSS OR DAMAGE ARISING OUT OF THE INSTALLATION, USE OR INABILITY TO USE THE PRODUCTS. THE ABOVE WARRANTY IS IN LIEU OF ALL OTHER WARRANTIES INCLUDING BUT NOT LIMITED TO WARRANTIES OF MERCHANTABILITY AND FITNESS FOR A PARTICULAR PURPOSE.

AtlasIED does not assume, or does it authorize any other person to assume or extend on its behalf, any other warranty, obligation, or liability. This warranty gives you specific legal rights and you may have other rights which vary from state to state.

### SERVICE

Should your CLA Series Amplifier require service, please contact the AtlasIED warranty department through the online warranty claim process.

#### Online Warranty Claim Processes

1. Warranty submissions are accepted at: [https://www.atlasied.com/warranty\\_statement](https://www.atlasied.com/warranty_statement) where the type of return Warranty or Stock return can be selected.
2. Once selected, you will be prompted to enter your login credentials. If you do not have a login, register on the site. If already logged-in, navigate to this page by selecting "Support" and then "Warranty & Returns" from the top menu.
3. In order to file a Warranty Claim, you will need:

- A. A copy of the invoice / receipt of the purchased item
- B. Date of Purchase
- C. The product name or SKU
- D. The serial number for the item (if no serial number exists, enter N/A)
- E. A brief description of the fault for the claim

4. Once all required fields are completed, select the "Submit Button". You will receive 2 emails:
  - (1) with a confirmation of the submission .
  - (2) with a case# for your reference should you need to contact us.

Please allow 2-3 business days for a response with a Return Authorization (RA) number and further instructions.

AtlasIED Tech Support can be reached at  
1-800-876-3333  
[atlasied.com/support](https://www.atlasied.com/support)

Visit our website at [www.AtlasIED.com](http://www.AtlasIED.com) to see other AtlasIED products.